

**BANDSCHWADER
FÜR EINACHSER**



FASTER



BANDSCHWADER SERIE FASTER

Die **bandschwader serie FASTER** sind handelt sich um Schwader mit 2 Bändern mit je 2 Zinken pro Kamm.

Der Unterschied zur Serie MC besteht darin, dass der FASTER nur über den Lenkhebel verfügt, während die Arbeitshöhe über die beiden Radträger eingestellt wird. Dieses Modell ist gegenüber dem MC in mehr Breiten erhältlich, ist leichter und somit einfacher für die Nutzung an **Hängen geeignet**. Er ist auch in der Ausführung „**CASTOR**“ mit freilaufenden (drehbaren) Rädern erhältlich.

SERIENMÄSSIG:

Konstruktion nach CE-Norm

Doppelriemen mit 2 Zinken pro Stange

Einstellbarer Lenkhebel (an Standardausführung)

Schnell- oder Flanschkupplung für Einachser

Heuschutz mit Zähnen

Lange/ mittlere/ kurze Anschlusshalterung

Aufblasbare Richtungsräder 3,50 x 8"

Sandstrahlung und Pulverbeschichtung im Ofen

2 Jahre Garantie

Abb. 1 Bandschwader **FASTER 22**

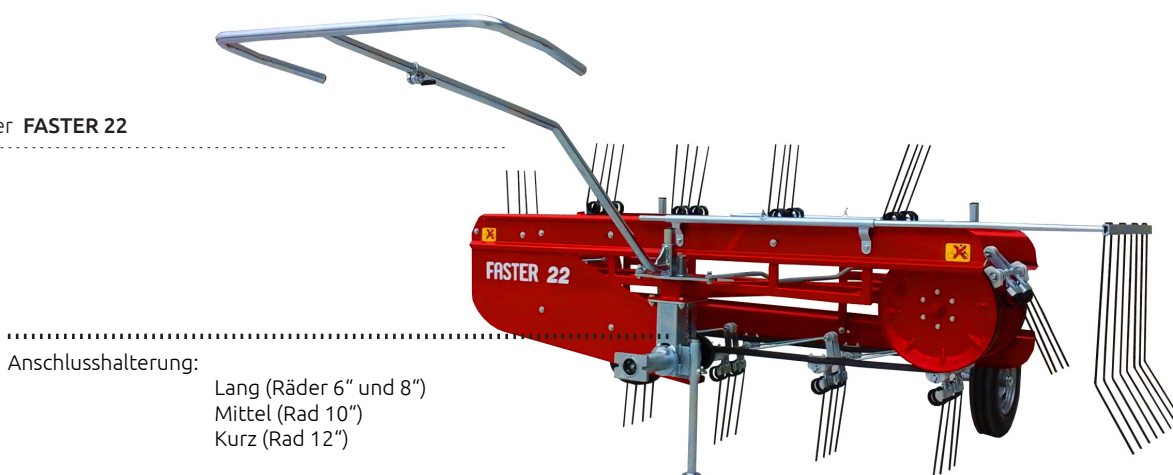









Anschlusshalterung:

Lang (Räder 6" und 8")

Mittel (Rad 10")

Kurz (Rad 12")

MOD.	 X	 (CM)	 (CM)	 (KG)	 (KW/ HP)	 (UMDREHUNGEN/ MIN.)			
FASTER 16	8x2	125	145x130x110h	128	6/8	900	✗	✓	0
FASTER 18	9x2	145	165x130x110h	140	7,5/ 10	900	✗	✓	0
FASTER 20	10x2	165	185x130x110h	146	9/ 12	900	✗	✓	0
FASTER 22	11x2	185	205x130x110h	154	10/ 13,5	900	✗	✓	1
FASTER 16 CASTOR	8x2	125	145x130x110h	123	6/8	900	✓	✗	0
FASTER 18 CASTOR	9x2	145	165x130x110h	135	7,5/ 10	900	✓	✗	0
FASTER 20 CASTOR	10x2	165	185x130x110h	141	9/ 12	900	✓	✗	0
FASTER 22 CASTOR	11x2	185	205x130x110h	150	10/ 13,5	900	✓	✗	1

BANDSCHWADER SERIE FASTER

Abb. 2 Bandschwader **FASTER 16**



Abb. 3 Detail **drehbares Rad**
(FASTER CASTOR)

Abb. 4 Detail **lenkbares Rad**



Abb. 5 Anbau mit **Hydraulikmotor**

EXTRA:

Heuschutz aus gummiertem Gewebe

Zwei Gegengewichte an Rädern

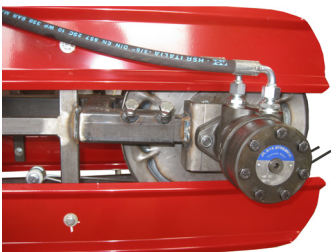
3-Zahn-Buchse (BCS/ GRILLO/ BUCHER/ KOPPL usw.)

Einstellbares Gegengewicht

Räder 15,00 x 6"- 6 Gewebe



www.meccanicamorellato.it

MECCANICA MORELLATO S.r.l.

Via Provinciale, 36
35010 Carmignano di Brenta (PD)

Tel. 049 595 7274

info@meccanicamorellato.it

